

GRUA TORRE TOWER CRANE

J600.20

UNE 58-101-92
FEM 1001-87
Directivas de nivel de potencia acústica / Sound power level directives
84/534/CEE & 87/405/CEE
Directivas de máquinas / Machinery directives
89/392/CEE & 91/368/CEE

SISTEMA DE CALIDAD CERTIFICADO SEGUN
QUALITY ASSURANCE SYSTEM CERTIFIED ACCORDING TO

UNE-EN-ISO 9001

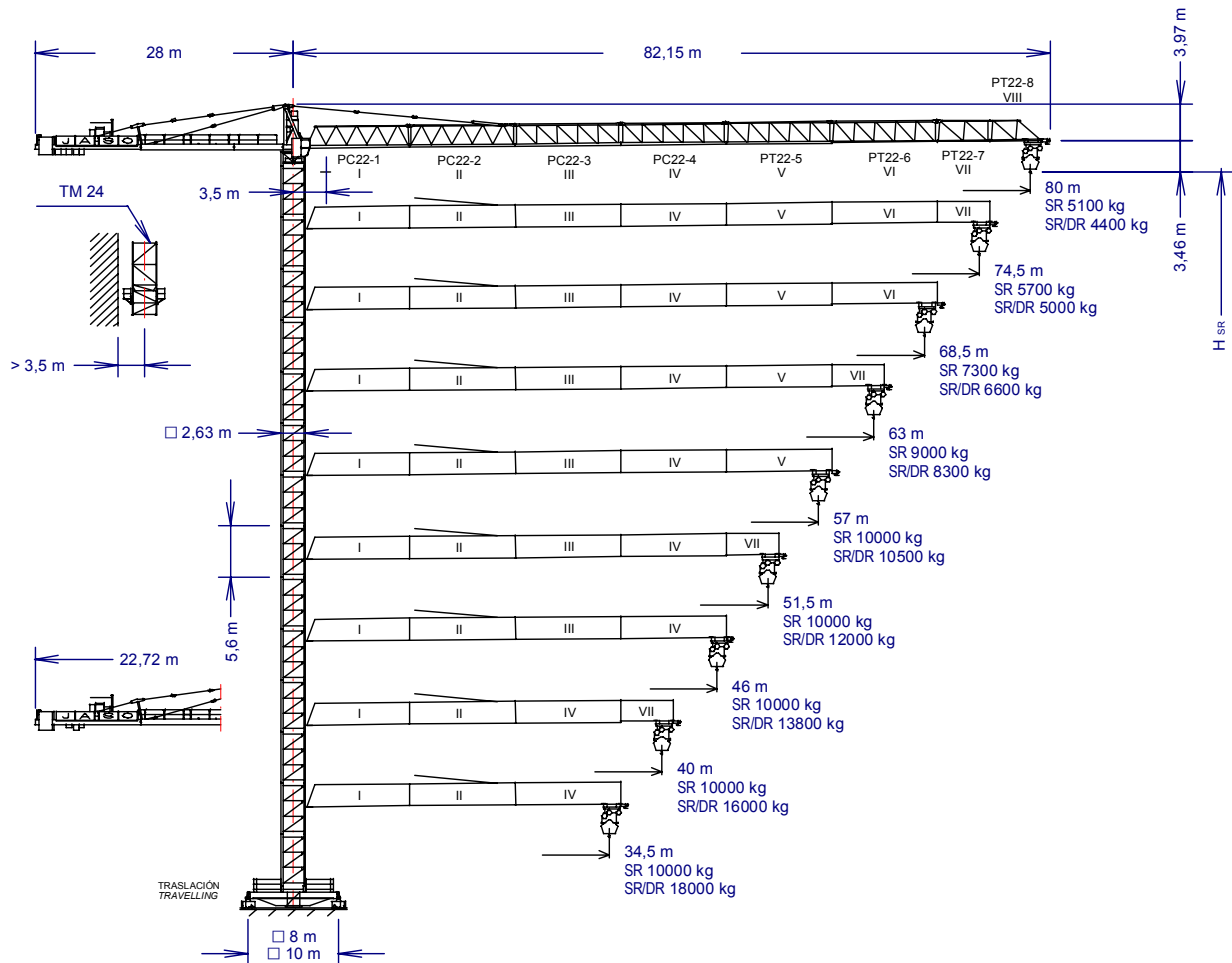

$H_{DR} = H_{SR} - 0,9$
 H_{SR} = Altura máxima bajo gancho sin arriostrar (m)
Maximum height under hook without fastening

PC22-1	156.40.000
PC22-2	156.41.000
PC22-3	156.42.000
PC22-4	156.43.000
PT22-5	156.44.000
PT22-6	156.45.000
PT22-7	156.46.000
PT22-8	156.47.000
TM 24	156.35.000

T24-2,8	156.32.000
T24-5,6	156.31.000
TR24-5,6A	156.31.500
TR24-5,6	156.30.000
BN 10-24	156.20.000
BN 8-24	156.20.500
ABE 130	156.23.000
AT 24	156.19.000
ATR 24	156.19.500
AND 24	156.21.000
ARD 24	156.21.300

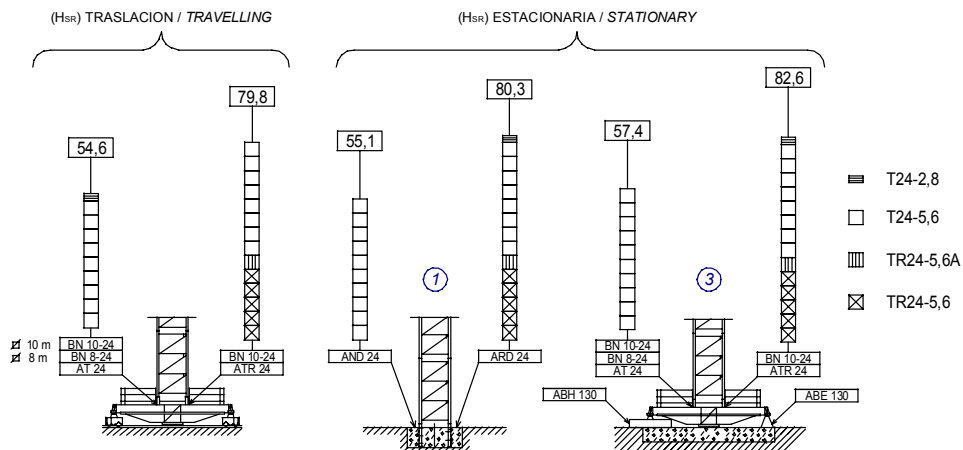







JASO EQUIPOS DE OBRAS Y CONSTRUCCIONES, S.L.

Fecha / Date: 11-11-04 - Reservado el derecho a modificaciones sin previo aviso / Subject to modification, without previous warning











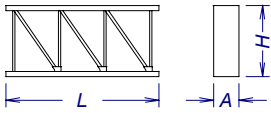
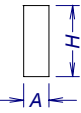
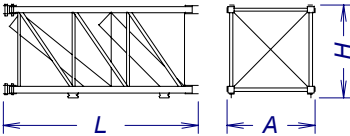
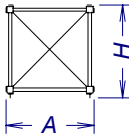
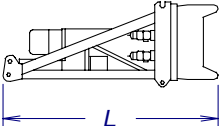
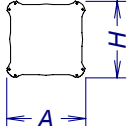
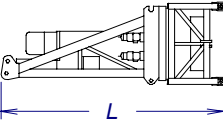
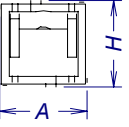
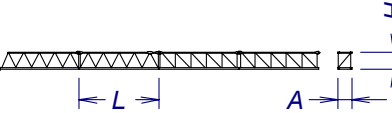

 SR (kg)	Cargas máximas / Maximum loads										9000-10000 kg a ... (m)	
	SR1 - 9000 SR2 - 10000											
PLUMA JIB	Alcance del gancho (m) / Hook reach (m)											kg a ... (m)
	80	74,5	68,5	63	57	51,5	46	40	34,5	30	25	
80 m	5100	5585	6210	6880	7765	8750	9000-9980	9000-10000	9000-10000	9000-10000	9000-10000	50,29-45,91
74,5 m	—	5700	6330	7015	7910	8915	9000-10000	9000-10000	9000-10000	9000-10000	9000-10000	51,09-46,64
68,5 m	—	—	7300	8070	9000-9075	9000-10000	9000-10000	9000-10000	9000-10000	9000-10000	9000-10000	57,41-52,42
63 m	—	—	—	9000	9000-10000	9000-10000	9000-10000	9000-10000	9000-10000	9000-10000	9000-10000	63-57,52
57 m	—	—	—	—	9000-10000	9000-10000	9000-10000	9000-10000	9000-10000	9000-10000	9000-10000	57
51,5 m	—	—	—	—	—	9000-10000	9000-10000	9000-10000	9000-10000	9000-10000	9000-10000	51,5
46 m	—	—	—	—	—	—	9000-10000	9000-10000	9000-10000	9000-10000	9000-10000	46
40 m	—	—	—	—	—	—	—	9000-10000	9000-10000	9000-10000	9000-10000	40
34,5 m	—	—	—	—	—	—	—	—	9000-10000	9000-10000	9000-10000	34,5

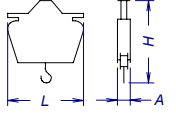
 SR / DR (kg)	Cargas máxima / Maximum loads										9000-10000 18000-20000 kg a ... (m)	
	SR1 /DR1- 9000 /180000 SR2 /DR2- 10000 /20000											
PLUMA JIB	Alcance del gancho (m) / Hook reach (m)											kg a ... (m)
	80	74,5	68,5	63	57	51,5	46	40	34,5	30	25	
80 m	4400	4885	5510	6180	7065	8050	9000-9280	9000-10000	9000-10000	9000-10000	9000-10000	47,14-43,27
							9280	11000	13105	15400	18000-18920	26,14-23,78
74,5 m	—	5000	5630	6315	7210	8215	9000-9460	9000-10000	9000-10000	9000-10000	9000-10000	47,89-43,97
							9460	11210	13350	15680	18000-19255	26,55-24,16
68,5 m	—	—	6600	7370	8375	9000-9505	9000-10000	9000-10000	9000-10000	9000-10000	9000-10000	53,82-49,41
						9505	10905	12870	15270	17895	18000-20000	29,84-27,15
63 m	—	—	—	8300	9000-9405	9000-10000	9000-10000	9000-10000	9000-10000	9000-10000	9000-10000	59,06-54,22
					9405	10645	12180	14335	16975	18000-19850	18000-20000	32,75-29,8
57 m	—	—	—	—	9000-10000	9000-10000	9000-10000	9000-10000	9000-10000	9000-10000	9000-10000	57
					10500	11855	13535	15895	18000-18780	18000-20000	18000-20000	35,84-32,61
51,5 m	—	—	—	—	9000-10000	9000-10000	9000-10000	9000-10000	9000-10000	9000-10000	9000-10000	51,5
					12000	13700	16010	18000-19000	18000-20000	18000-20000	18000-20000	36,2-32,94
46 m	—	—	—	—	—	9000-10000	9000-10000	9000-10000	9000-10000	9000-10000	9000-10000	46
						13800	16200	18000-19135	18000-20000	18000-20000	18000-20000	18000-20000
40 m	—	—	—	—	—	—	9000-10000	9000-10000	9000-10000	9000-10000	9000-10000	40
							16000	18000-18900	18000-20000	18000-20000	18000-20000	18000-20000
34,5 m	—	—	—	—	—	—	—	9000-10000	9000-10000	9000-10000	9000-10000	34,5
								18000	18000-20000	18000-20000	18000-20000	18000-20000

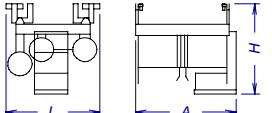
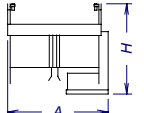
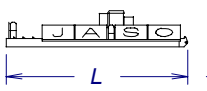
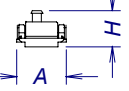
CARACTERISTICAS DE MECANISMOS / MECHANISMS FEATURES

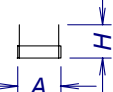
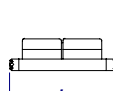
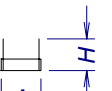
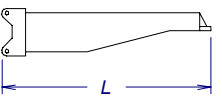
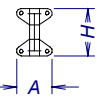
MECANISMOS MECHANISMS	*opcional *optional								
	EC10075VF	*EC150115VF	EC10065VF	* EC150100VF					
kW	75	110	75	110	4 x 7,5	4 x 7,5	8,8	18,4	
VELOCIDADES SPEEDS	SR1 2900 kg 4800 kg 9000 kg	0...7...19...38...56...75 0...7...19...38...56 0...7...19...38	0...11...29...58...86...115 0...11...29...58...86 0...11...29...58	SR2 3500 kg 5500 kg 10000 kg	0...8...17...33...49...65 0...8...17...33...49 0...8...17...33	0...10...26...50...76...100 0...10...26...50...76 0...10...26...50	0...0,1 0,1...0,3 0,3...0,6 r/min sl/min	10000 kg 0...90 m/min 20000 kg 0...45 m/min	0,6 m/min
	DR1 5800 kg 9600 kg 18000 kg	0...4...10...19...28...38 0...4...10...19...28 0...4...10...19	0...6...15...28...43...58 0...6...15...28...43 0...6...15...28	DR2 7000 kg 11000 kg 20000 kg	0...4...8...17...25...33 0...4...8...17...25 0...4...8...17	0...5...13...25...38...50 0...5...13...25...38 0...5...13...25			
Máx. recorrido gancho Maximum hook course	SR	278m 486m	3 capas / layers 5 capas máx. / max. layers	DR	139m 243m	3 capas / layers 5 capas máx. / max. layers	 400V 50Hz Potencia necesaria con ... Power required with ... EJ10065VF/EJ10075VF = 143,8 kW EJ150100VF/EJ150115VF = 178,8 kW	 480V 60Hz Potencias y velocidades: 20% más Powers and speeds: 20% more	

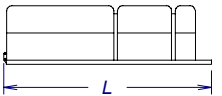

DENOMINACION / DENOMINATION		L (m)	A (m)	H (m)	P / W (kg)
Torre desmontada <i>Dismantled tower</i>	T24-5,6			5,965	3800
	T24-2,8			3,165	2000
	TR24-5,6			5,99	4880
	TR24-5,6A			5,98	4750
Torre montada <i>Assembled tower</i>	T24-5,6			5,965	4180
	T24-2,8			3,165	2380
	TR24-5,6			5,99	5260
	TR24-5,6A			5,977	5130
Conjunto punta de torre, interior asiento pista y orientación <i>Tower head assembly, slewing table inside and slewing mechanism</i>				6,337	11873
Conjunto asiento pista, punta de torre y orientación <i>Slewing table assembly, tower head and slewing mechanism</i>				6,963	15723
Tramo pluma <i>Jib section</i>	TC22-1 (I)			11,645	5091
	TC22-2 (II)			11,742	5737
	TC22-3 (III)			11,742	5917
	TC22-4 (IV)			11,742	5130
Tramo pluma <i>Jib section</i>	PT22-5 (V)			11,742	2915
	PT22-6 (VI)			11,742	1983
	PT22-7 (VII)			5,917	1098
	PT22-8 (VIII)			5,86	679
Polipasto <i>Hook assembly</i>	SR			1,541	452
	DR			1,849	996
Carro <i>Crab</i>	SR			2,523	959
	DR			2,634	1185
Contrapluma con plataformas <i>Counterjib with platforms</i>				11,51	9150
Prolongación larga de contrapluma con plataformas <i>Large counterjib extension with platforms</i>				10,42	4100
Prolongación contrapluma con plataformas <i>Counterjib extension with platforms.</i>				5,513	2500
Testero largo de base <i>Long base carriage</i>				7,913	4810
Testero corto de base <i>Short base carriage</i>				6,946	3430
Plataforma de base <i>Base platform</i>				3,972	216

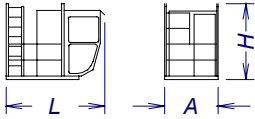
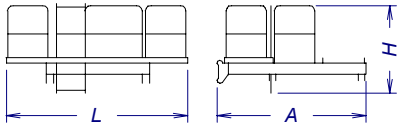
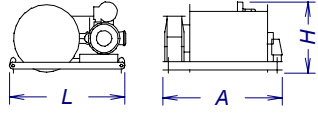
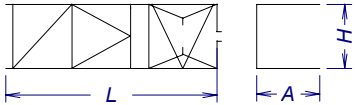

DENOMINACION / DENOMINATION		L (m)	A (m)	H (m)	P / W (kg)
Plataforma inferior y cabina <i>Lower platform and cabin</i>		3,12	1,7	2,435	1325
Plataforma de cabina <i>Cabin platform</i>		3,283	2,698	1,414	405
Soporte y elevación <i>Support and hoisting</i>		2,500	2,100	1,250	3325
Torre de montaje montada <i>Assembled jacking cage</i>		11,26	3,681	3,542	12527

LASTRES INFERIORES / LOWER BALLASTS		Para alturas intermedias tomar el lastre correspondiente a la altura superior <i>For intermediate heights take the ballast corresponding to the higher height</i>		
BN 10-24	Altura bajo gancho (m) / <i>Height under hook (m)</i>	82,6	57,4	35
Número de piedras a colocar <i>Number of ballast blocks to put</i>	Piedras de 6000 kg <i>Blocks of 6000 kg</i>	12	8	4
BN 8-24	Altura bajo gancho (m) / <i>Height under hook (m)</i>	57,4	40,6	29,4
Número de piedras a colocar <i>Number of ballast blocks to put</i>	Piedras de 6000 kg <i>Blocks of 6000 kg</i>	14	12	10

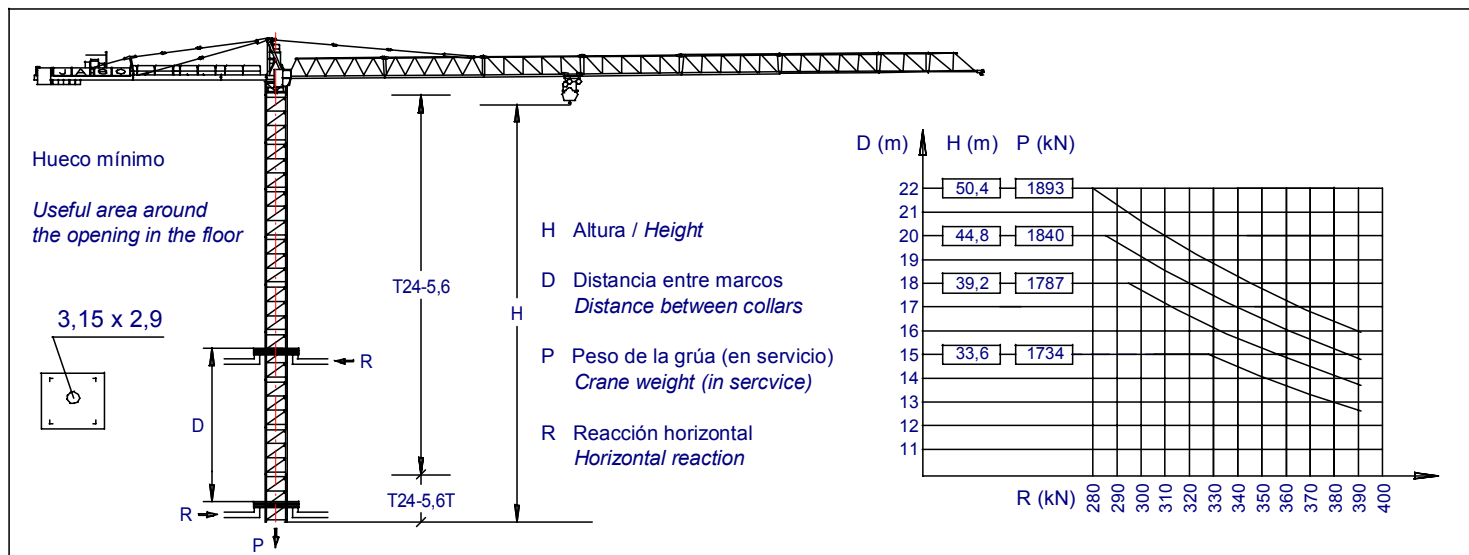

JASO EQUIPOS DE OBRAS Y CONSTRUCCIONES, S.L

Ctra./Rd. Madrid - Irún Km. 415
20.213 IDIAZABAL (Gipuzkoa)
ESPAÑA / SPAIN
P.O. Box, 23 - 20.200 BEASAIN

Tel. +34 943 - 18 70 00
Fax. +34 943 - 18 70 20
E-mail: jaso@jaso.com
http://www.jaso.com

Fecha / Date: **11-11-04**

Reservado el derecho a modificaciones sin previo aviso / *Subject to modification, without previous warning*

DELEGACION / *DELEGATION*